



SCIENCE & TECHNOLOGY FOR NEW DoD CAPABILITIES :
INTERDISCIPLINARY RESEARCH EXAMPLES
IN OPTICAL SCIENCE AT NRL

A. J. Campillo

Naval Research Laboratory

Optical Physics Branch, Code 5610

Washington, DC 20375-5338



OUTLINE



BASIC SCIENCE IN NAVY

- Enhances mission capabilities

EXAMPLES

- * IR QW lasers for countermeasures
- * Optical limiters for eye protection
- * Organic LEDs for flat panel emissive displays
- * Nanochannel Glass- Neural interface
- * Chem /Bio sensing using luminescent quantum dots
- * Optical materials for radiation dosimetry
- * Optical point detection of bio-aerosols

UNIVERSITY BASIC RESEARCH

Curiosity driven

Fundamental concepts

hypotheses, new principles, mathematical models

Historically, has led to important technology breakthroughs (not required).



NAVY BASIC RESEARCH

Long - range targeted research (goal/mission oriented)

Fundamental issues still explored - issues studied specific to application

“problem looking for solution”

NAVY FUNDING CATEGORIES

6.1 → **6.2** → **6.3** → **6.4** → **6.5**

Basic
Research

Applied
Research

Advanced
Technology
Development

Acquisition,
Operations,
Maintenance, etc.

Criterion for success is “transition” (e.g., **6.1** → **6.2** , **6.2** → **6.3**)



COUNTERMEASURE TO HEAT-SEEKING MISSILES

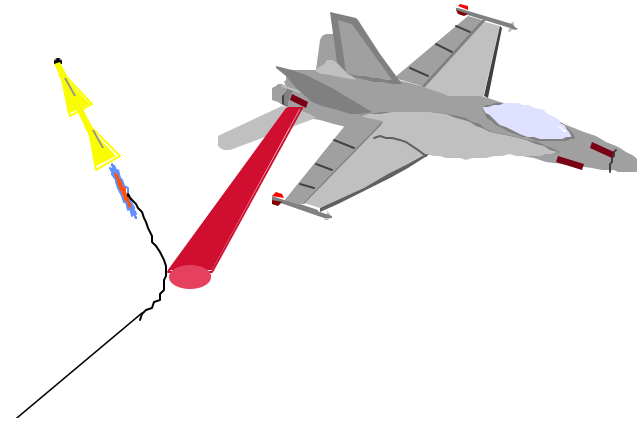
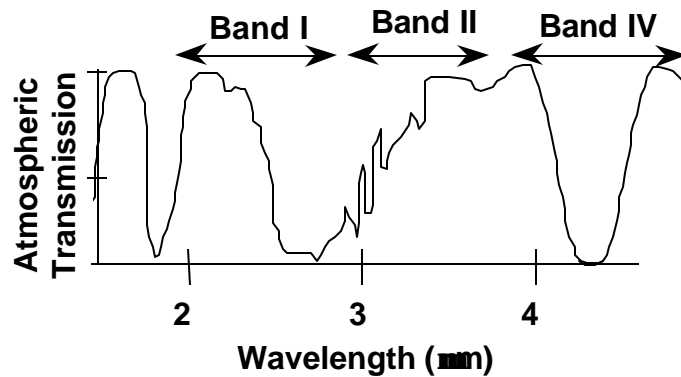

- IR-guided missiles caused $>70\%$ of U.S. aircraft combat losses since 1970
- Seeker detects mid-IR ($3\text{-}5\ \mu\text{m}$) blackbody radiation – Steers toward large warm objects
- **Countermeasure:** IR laser to jam sensors (Need $\approx 5\ \text{W}$ quasi-cw at room temp)
- **Problem:** Such lasers don't exist!
- **Solution:** Bandstructure-engineered type-II “W” lasers
 - *Antimonide quantum heterostructure materials development*
 - *Advanced computer design & simulations*



TYPE-II "W" QUANTUM WELL LASERS FOR THE MIDWAVE INFRARED

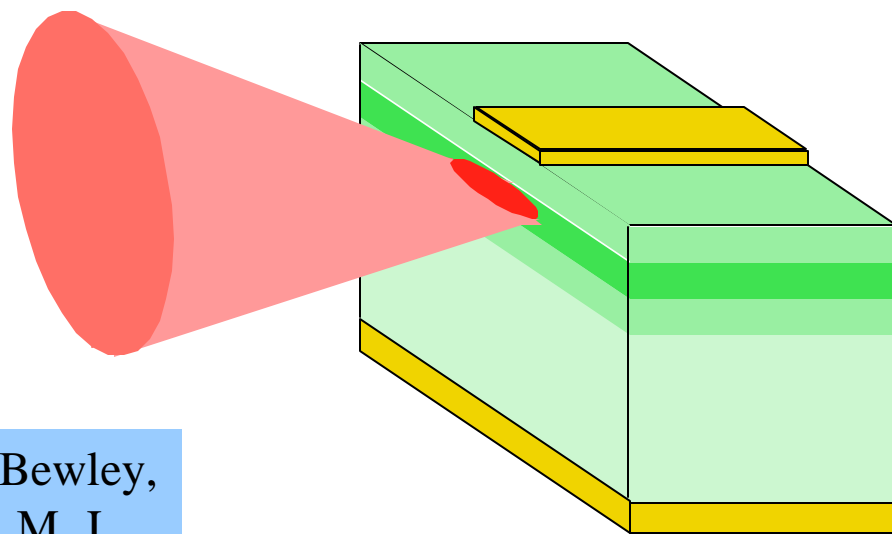

NRL Research Team: J. R. Meyer, W. W. Bewley,
I. Vurgaftman, C. L. Felix, R. E. Bartolo, M. J.
Jurkovic, J. R. Lindle, & M. J. Yang

In collaboration with: Sarnoff Corporation, MIT
Lincoln Lab, WPI, *et al.*



NRL TYPE-II "DUBYA" LASER

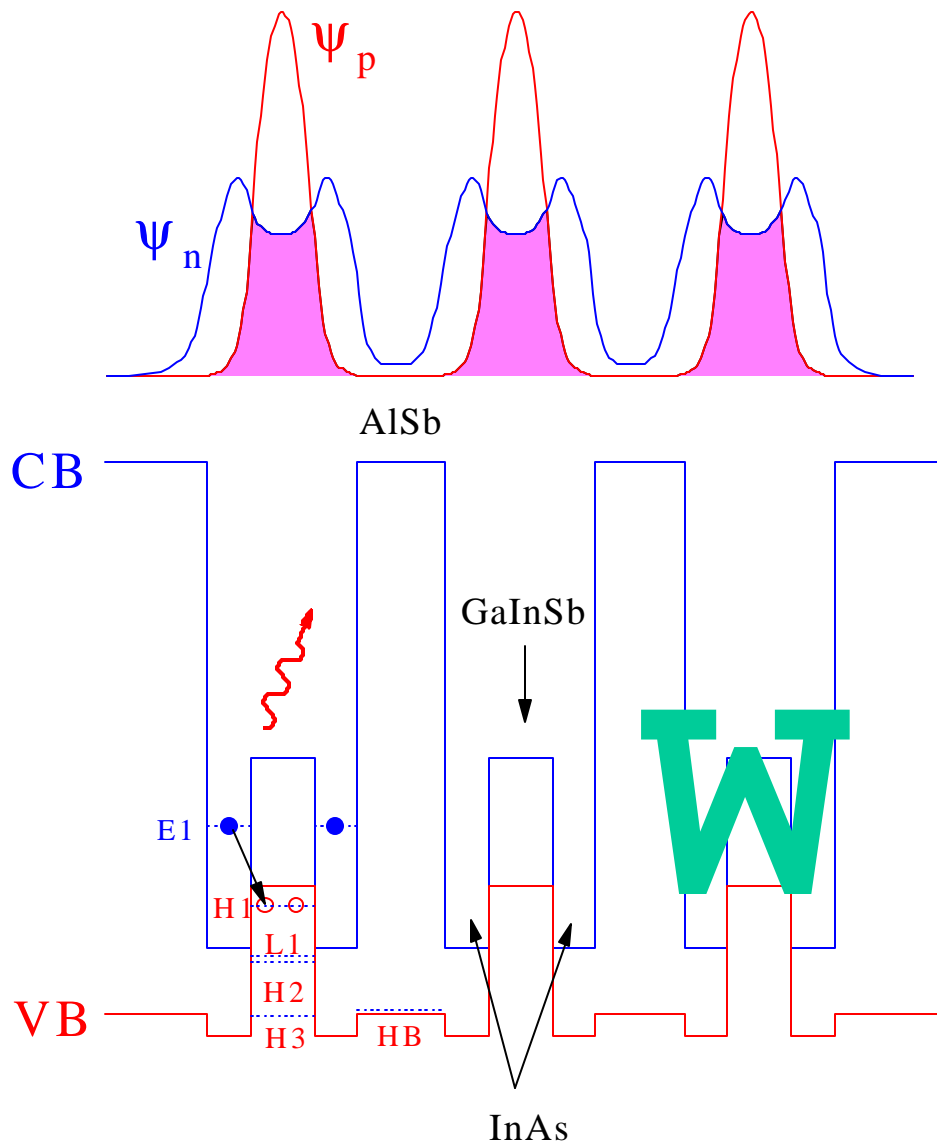

ADVANTAGES:

- (1) Strong wavefunction overlap
 - For high gain
- (2) 2D DOS for both electrons and holes
 - For high differential gain
- (3) Excellent electrical confinement
 - Prevents leakage
- (4) Auger suppression
 - Reduces threshold at high T

First room-temperature interband mid-IR laser (Pulsed optical pumping, 1996)

Meyer et al. APL 67,757 (1995)
U.S. Patent # 5,793,787

Programmatic *modus operandi*: Extensive simulation of *wavefunction-engineered* designs before device fabrication & testing

Based on 8-band finite-element $k \cdot p$, self-consistent beam propagation, *etc.*



CW MID-IR SEMICONDUCTOR LASERS

Felix et al., PTL 11, 964 (1999)

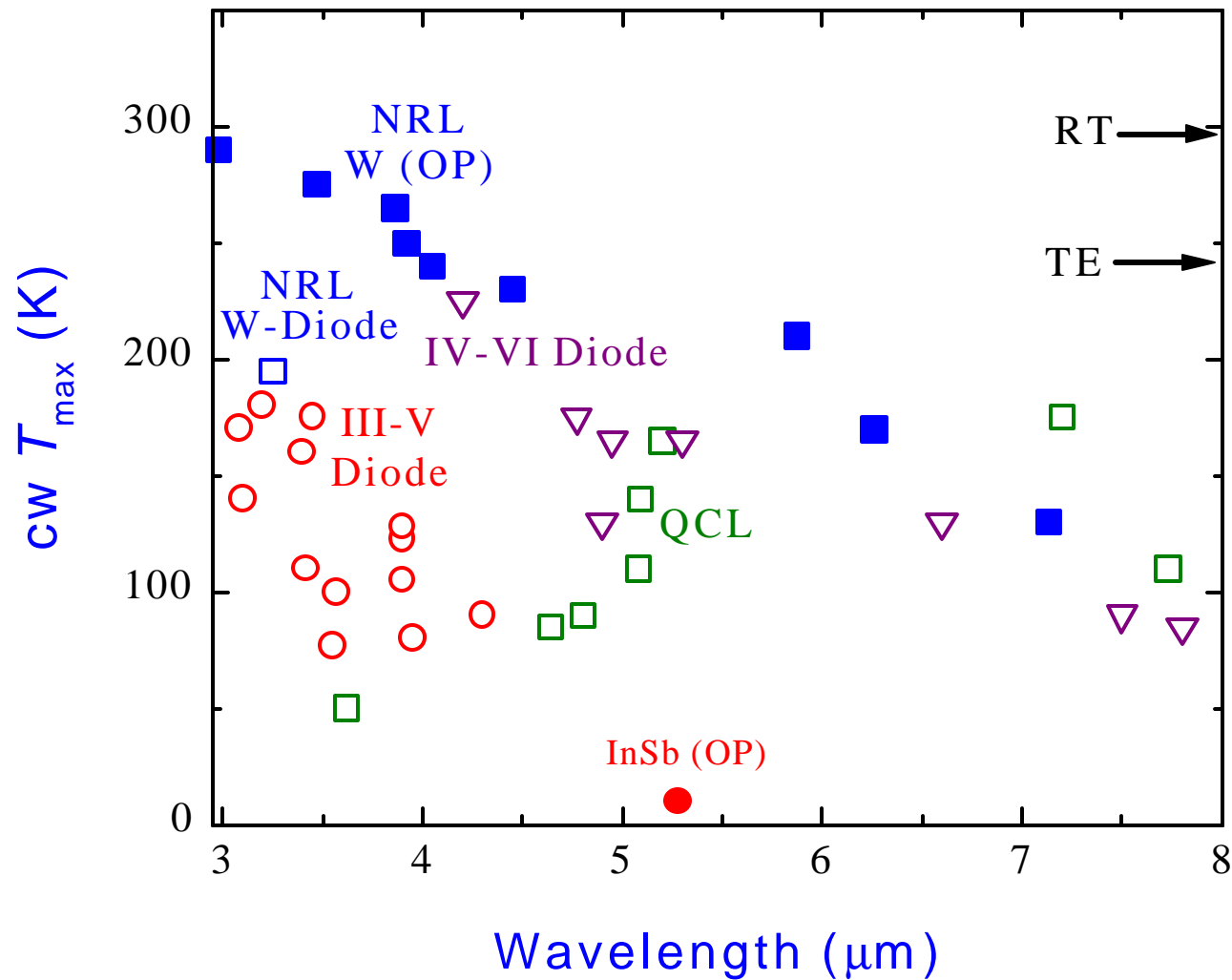

Only NRL W lasers give near-room-temperature cw operation in mid-IR



TRANSITIONS

- NRL W approach now under investigation by at least 7 other institutions (Sarnoff, AOI, MIT Lincoln Lab, UNM, Northwestern, U. Montpellier, Fraunhofer Inst.)
 - MIT-LL W laser array recently met specs for ATIRCM demo
- Also wide-gap W structures (InGaAs/GaPAsSb/InGaAs/GaAs) at Arizona State & UCSB for possible GaAs-based 1.3-1.55 μm communications lasers
- Transitions:
 - NRL 6.1 Research Option begins FY01 to develop antimonide laser materials
 - ONR 6.2 program to develop high-performance W devices
 - AFRL program to advance IRCM laser development
 - NavAir EWAT program to demo 5 W optically-pumped array by end of FY01 for possible IRCM transition
 - DARPA program (joint with Sarnoff, Focused Research) to develop continuously-tunable single-mode lasers for chemical sensing
- Sarnoff considering possible spin-off of mid-IR company based partly on W laser



Protection from Laser Threats

- Threats

- Hand held laser pointers
- Targeting, guidance lasers
- High Energy Lasers, Air borne laser
- Commercial - Laser Light shows
- Offensive weapons

- Protection Strategies

- **BROADBAND OPTICAL LIMITERS**

- Picosecond photochromic materials
- Best hope against a frequency agile tunable laser at unpredictable wavelengths





Optical Limiters at NRL

James S. Shirk - Code 5613

Arthur Snow
Eva Maya

Synthesis of New
Nonlinear materials

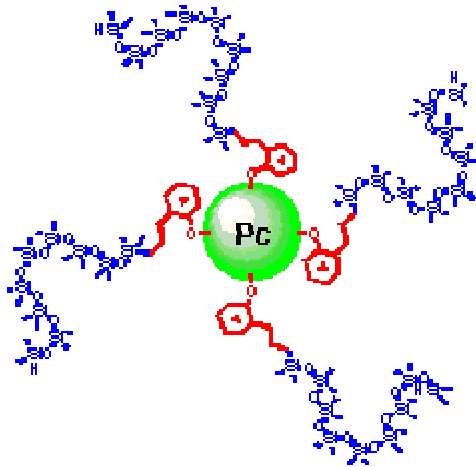

Armand Rosenberg

Fabrication of nanochannel glass
Photonic Band gap materials

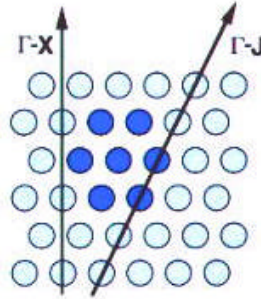

Joseph W Haus
Univ. of Dayton

Theory of Photonic
Band gap materials

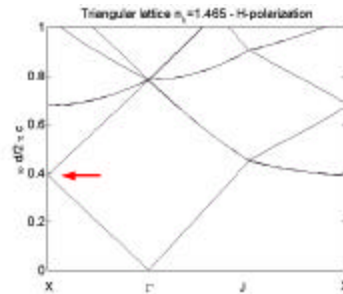

Steven Flom

Ultrafast Spectroscopy

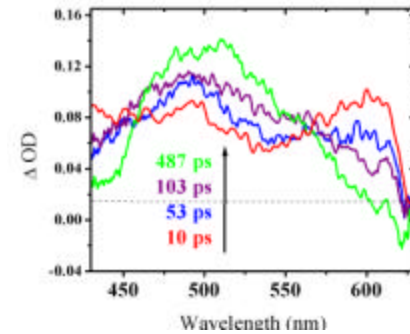

Richard G S Pong

Optical Limiter Test Bed
Nanosecond characterization

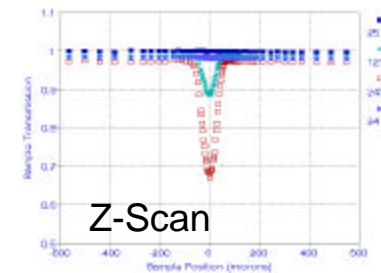



Optical Limiter Mechanisms

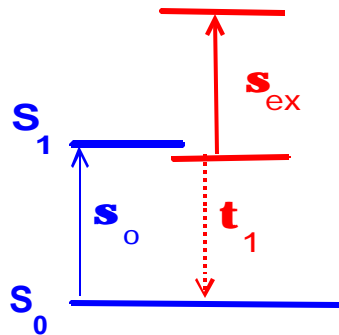

- Sequential absorption
 - $\sigma_{ex} \gg \sigma_0$ and $\tau > \tau_{laser}$
 - Low threshold
- Two Photon Absorption
 - Useful at high intensity
 - Less important for longer pulses where fluence (J/cm^2) is limited
- Nonlinear Refraction
 - Electronic and/or thermal
 - Long pulse, good dynamic range
 - Increases beam divergence if it is at an intermediate focus

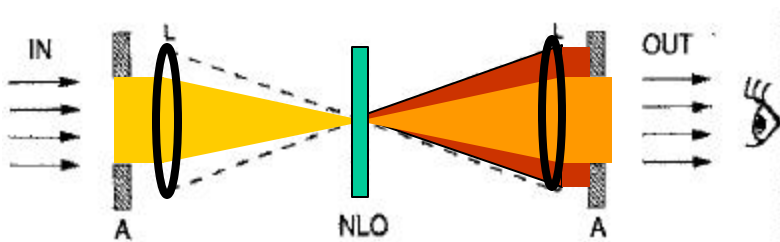



Optical Limiting

Mechanisms

Energy Levels

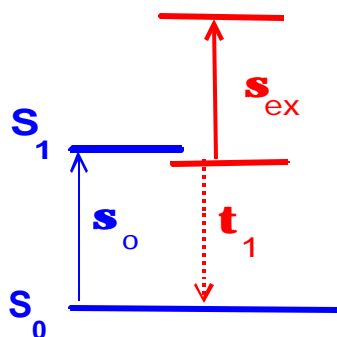

- Sequential Absorption

- Absorption of intense laser light increases population in excited state
- Absorbance increases for all wavelengths where $\sigma_{ex} \gg \sigma_0$

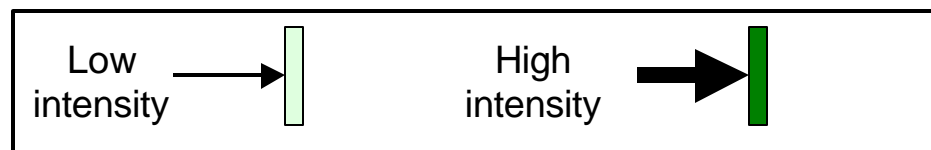

Spectra

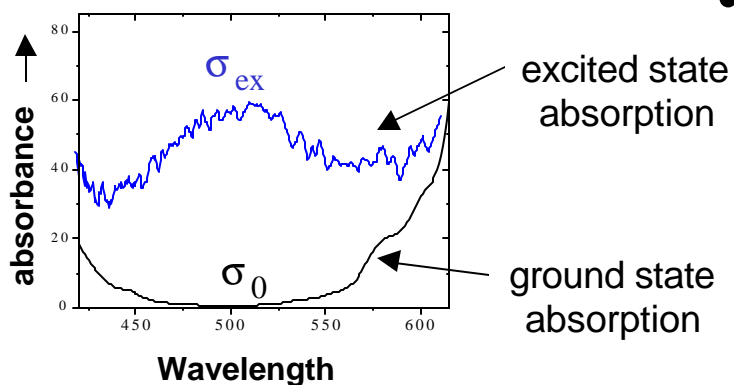

- The spectrum of the ground and excited states of this optical limiter molecule shows it can provide agile limiting across the visible



Agile Nonlinear Absorption Limiters

f/5 Limiter Response

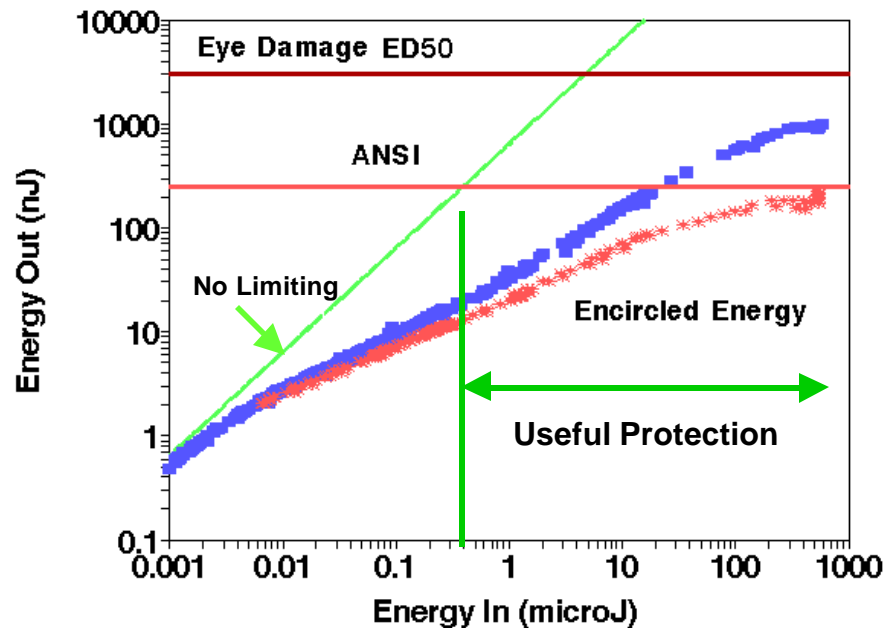

- Near ANSI Maximum Permissible Exposure Protection in Fast optical systems
- Lowest threshold and Long Dynamic Range
- Refractive beam distortion effects provide additional protection

- **Transitions to 6.3**

- Navair: Binocular demonstrator
- US Army: Tank periscope
- US Air Force: Head mounted goggle test bed

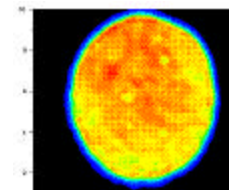

No Limiting

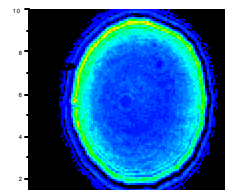

With Limiter T ~ 0.3%

FLEXIBLE ORGANIC EMISSIVE DISPLAYS

- *Command & control centers, maps & battle field simulators *Helmet mounted displays
- *Tank & aircraft cockpit displays *Portable computer & communications
- * Air traffic control, submarine, battlefield medicine *HDTV

**Display
Diagonal
Size**

**DARPA
15"**

10" →

NAVAIR

4" →

**NRL
1" →**





ORGANIC LIGHT-EMITTING MATERIALS & DEVICES

Zakya Kafafi (PI)

Hideyuki Murata, Gary Kushto, Lisa Picciolo and Antti Mäkinen

Objective: Develop thermally-stable, long-living, multi-colored, highly-efficient, organic electroluminescent displays

Features:

- Thin and light-weight flexible displays
- Low operating voltage
- Self-emissive
(No need for an external light source)
- High efficiency and brightness
- Sunlight readable
- High resolution
- Wide operating temperature (-150 °C to 90°C) range
- Excellent viewing angle (> 170° vertical & horizontal)
- High durability (>10,000 hrs)
- Shock resistant
- Environmentally safe

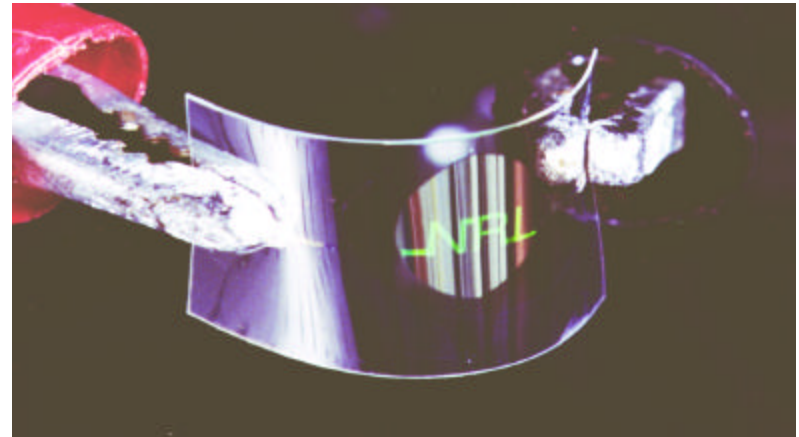



ORGANIC LIGHT-EMITTING MATERIALS & DEVICES

Approach



Metal Cathode

Electron Transport Layer

Emissive Layer

Hole Transport Layer

ITO Anode

Transparent Substrate

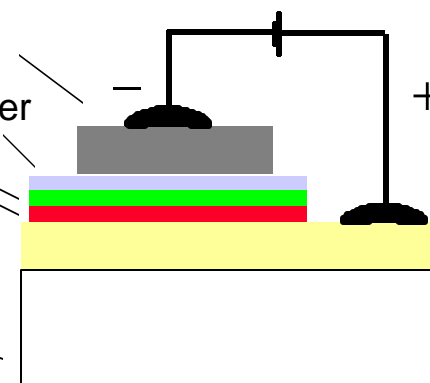

Develop thermally stable, highly efficient luminescent composites for high performance molecular organic light-emitting diodes (MOLEDs)

Enhance electroluminescence quantum efficiency by efficient energy transfer from host to guest and/or direct carrier recombination on guest

Improve carrier injection and device lifetime by modifying organic/electrode interfaces, transport and emissive layers



ORGANIC LIGHT-EMITTING MATERIALS & DEVICES

Zakya Kafafi (PI)

Hideyuki Murata and Gary Kushto

- Demonstrated high efficiency MOLEDs with very low turn-on voltage (2.5V)
- Achieved high brightness (4000 cd/m²) at very low voltage (8V)
- Achieved high luminous power efficiency (10 lm/W at 10 cd/m²)

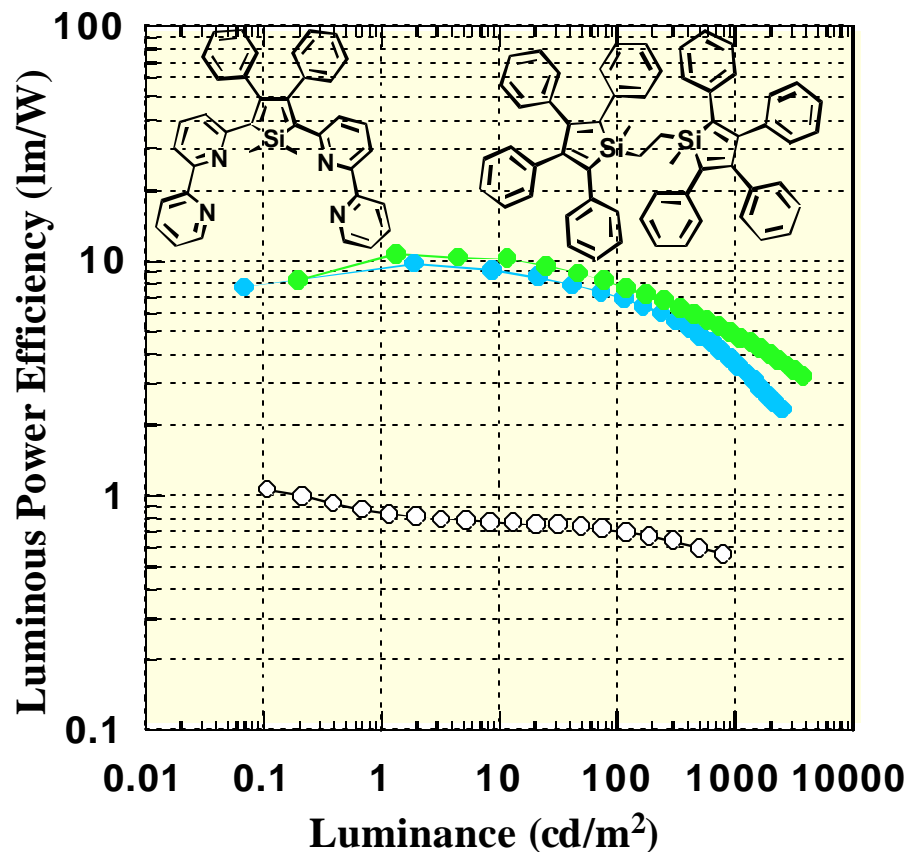
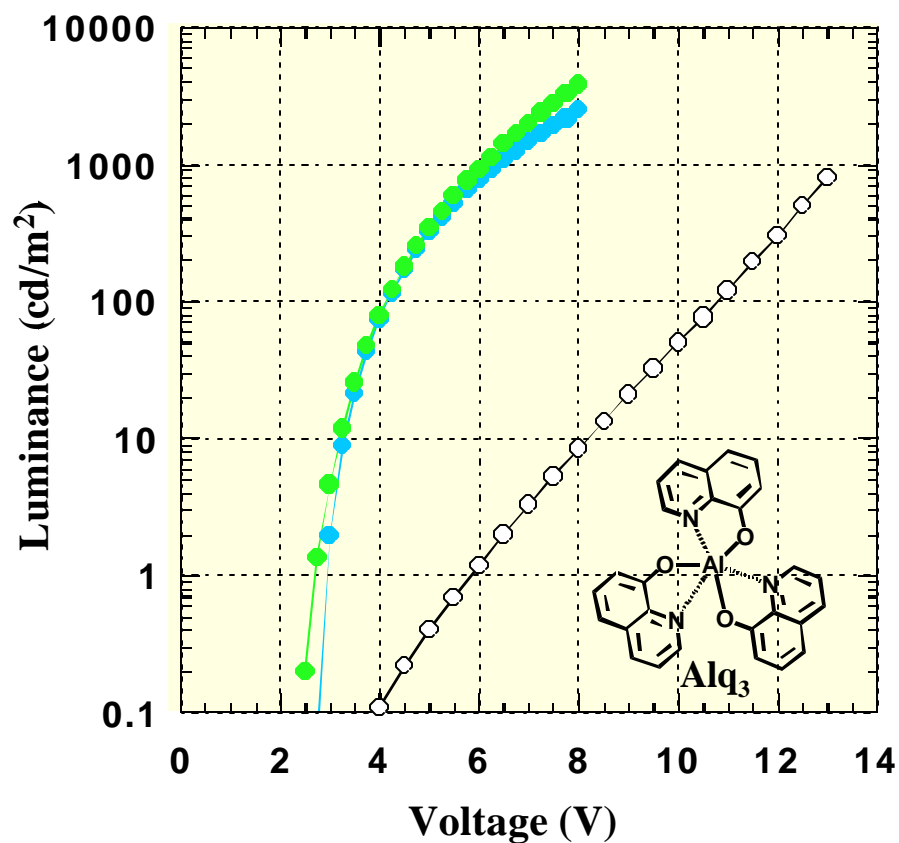



ORGANIC LIGHT-EMITTING MATERIALS & DEVICES

Zakya Kafafi (PI)

Hideyuki Murata and Charles Merritt

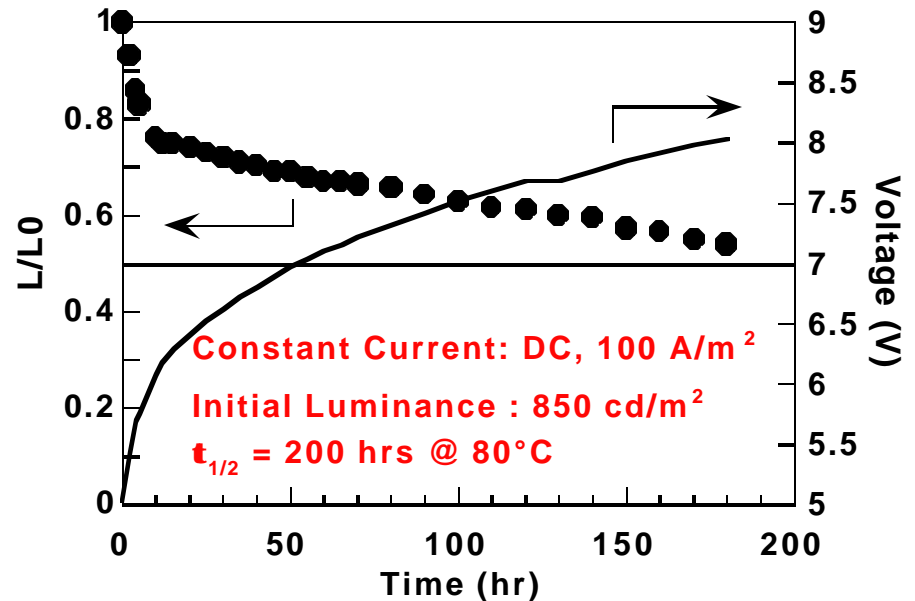
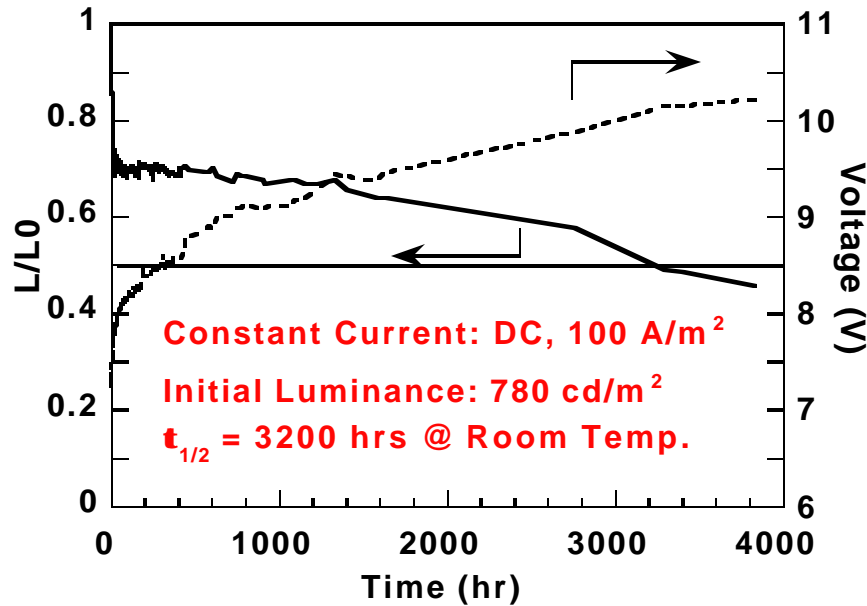

Transitions:

Funded by DARPA Flexible Display Program

Endorsed by the F/A-18 and UAV Advanced Technology Review Boards (ATRB)



Fabrication of Composite Nanostructures and Nanopatterned Substrates

NRL Accelerated Research Initiative on Nanostructured Arrays

Objectives:

- Develop nanochannel glass and related technologies that provide nanometer-scale periodic structures.
- Fabricate and characterize composite nanostructures and nanopatterned materials using nanochannel glass.

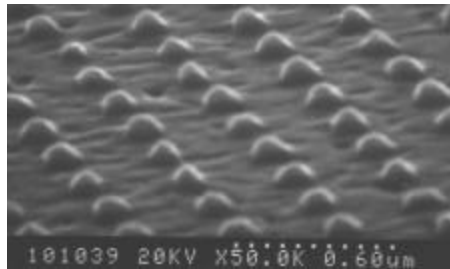

120 nm magnetic multilayer pillars (Fe/Au/Co/Au) grown by MBE using replica mask

Participants:

Optical Sciences Division

Chemistry Division

Electronics Division

Materials Science and Technology Division

250 nm HgCdTe dots made using RIE through NCG replica mask

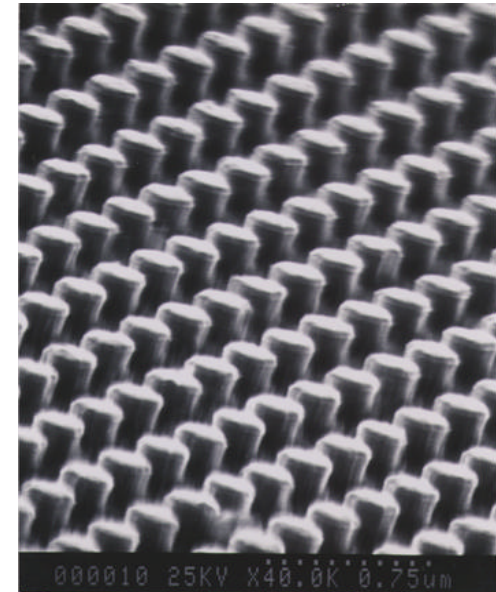



Nanochannel Glass (NCG)

- composite glass structure
- etchable glass removed with acid
- acid resistant glass left with micron or submicron-scale diameter channels
- channel diameters ranging from ~200 nm to ~2 μm
- aspect ratio of channels very high (2000:1)
- channels are parallel, uniform
- thermally stable to ~ 1000°C
- packing densities to ~ $10^9/\text{cm}^2$
- current samples contain ~ 10^6 pores
- glass can be cut, ground and polished to desired size and shape

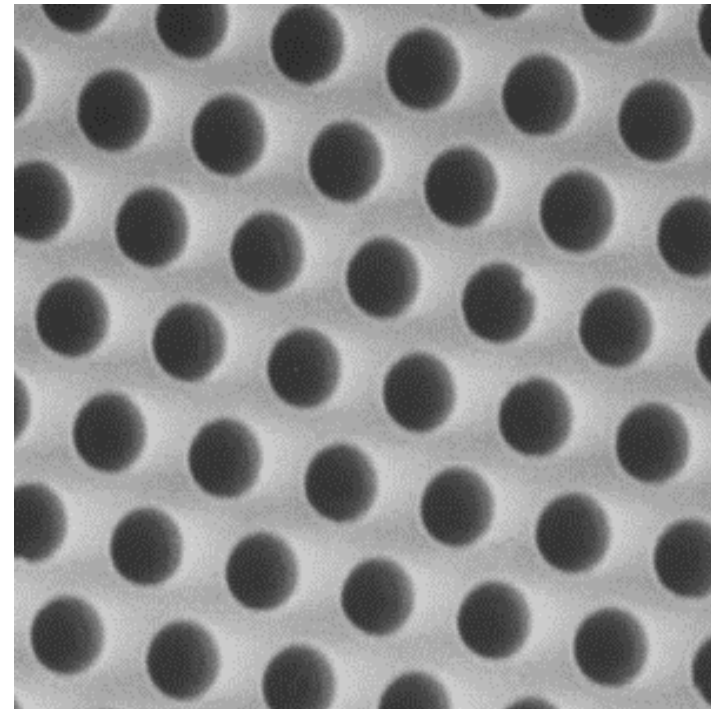

NCG with 450 nm pores



Nanochannel Glass Fabrication

Microchannel glass is fabricated by bundling composite glass fibers into a hexagon and drawing the bundle at elevated temperature.

1. Etchable glass rod is inserted into etch-resistant glass tube.

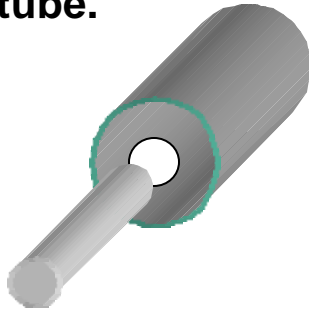

2. The nested rod and tube are drawn at elevated temperature to a fiber.

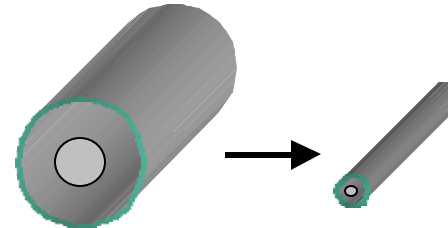

3. Fibers are bundled, clamped, and drawn into a hexagonal fiber.

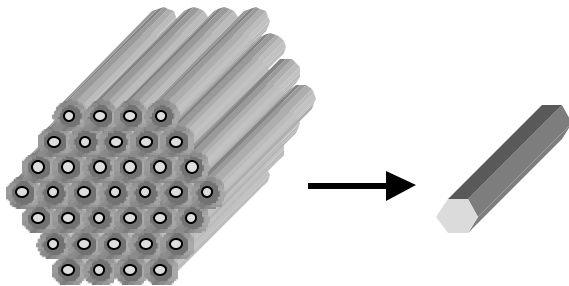

4. Hexagonal fibers are stacked in a 12-sided bundle and fused in a glass cladding under vacuum.

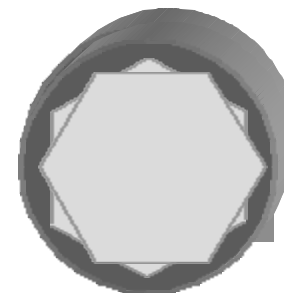

NCG can be made by stretching a microchannel glass boule to a taper.



Parallel Patterning using NCG Replica Mask

silicon pyramids

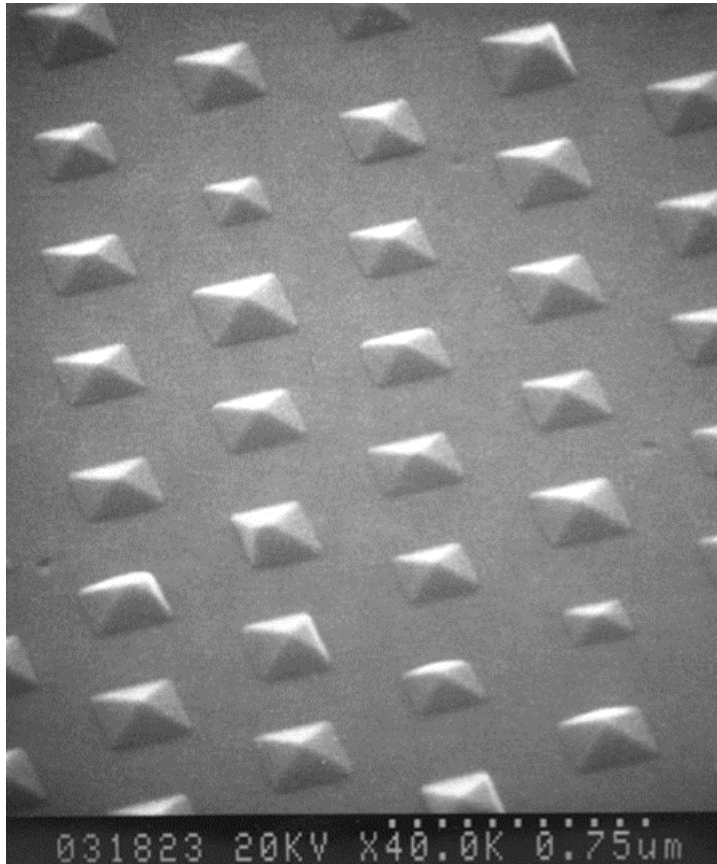

250 nm Si pyramids grown on Si substrate by MBE

nickel rings

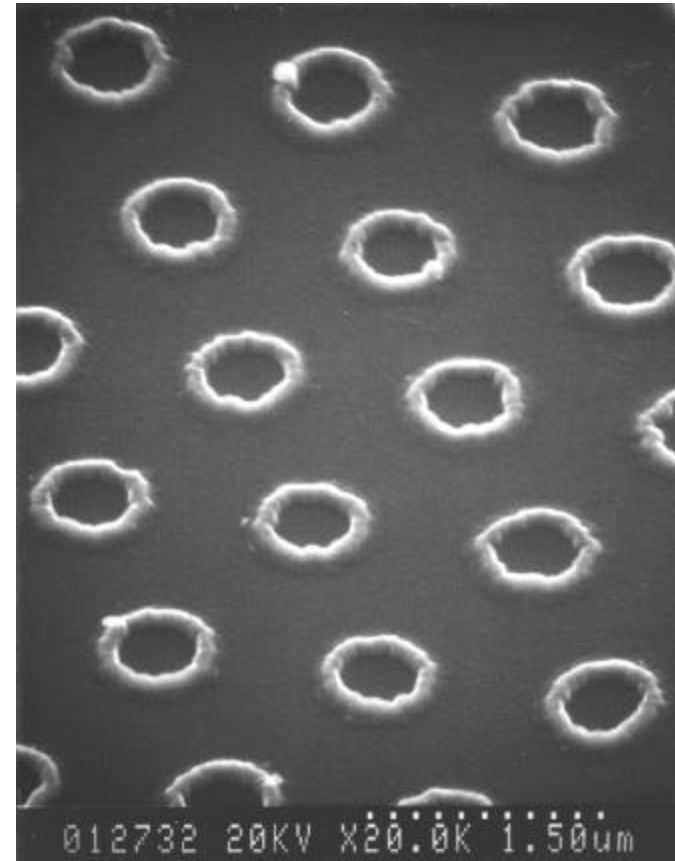

Wide area patterning of 0.75 micron Ni rings 70 nm high with 120 nm side-walls.



Artificial Retinal Stimulation

Objectives

Demonstrate a massive, parallel interface between a 2-D microelectronic stimulator array and neural tissue layers.

Approach:

Design and fabricate a retinal stimulator array for testing with blind human subjects in operating room conditions.

- infrared focal plane array multiplexer technology
- nanochannel glass technology

Investigators:

Brian Justus, Charles Merritt,
Paul Falkenstein and Dean Scribner
Optical Sciences Division, NRL

Mark Humayun and Jim Weiland
Johns Hopkins University
Wilmer Eye Institute

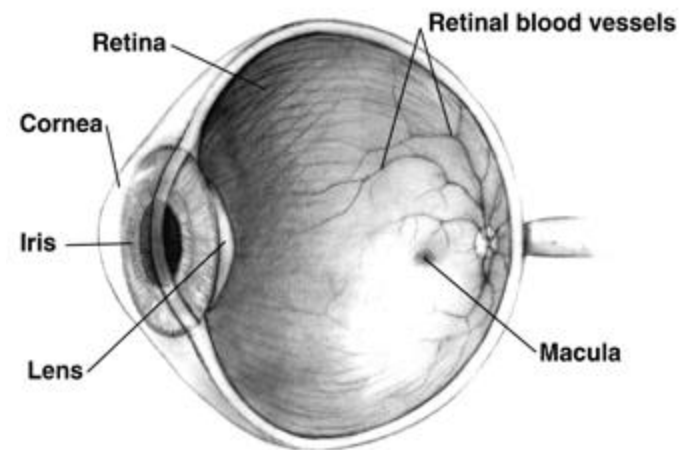

Research supported by DARPA



Nanochannel Glass Microelectrode Arrays

Nanochannel glass technology enables connections to millions of neurons

- excellent compatibility with biological tissue
- shape can be made to conform to curvature of any neural surface
- metal can be deposited in hollow channels to provide a uniform array of millions of metal electrodes
- microelectrodes offer micron-scale spatial resolution

Features:

- small electrodes (diameter = 1.6 μm)
- center to center spacing = 2.4 μm
- large array area ($> 1 \text{ cm}^2$)
- no channel crosstalk

NRL NCG is the only technology capable of providing large, parallel arrays of small, high-aspect-ratio conductors.

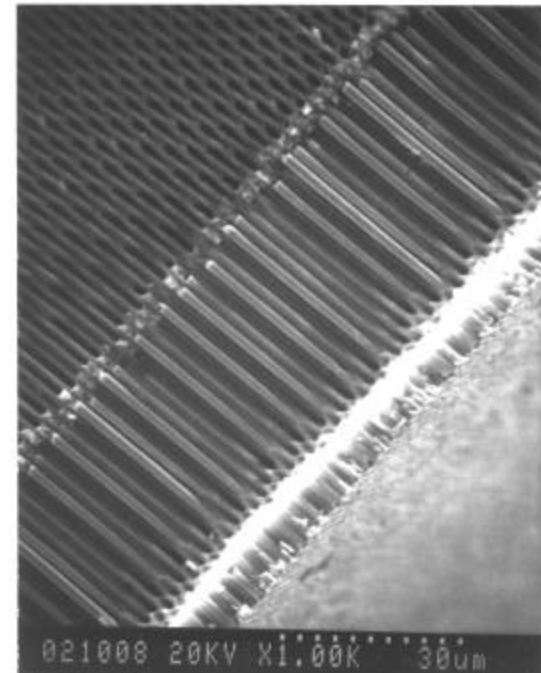

Electro-deposited Pt wires



Microelectronic Retinal Stimulator

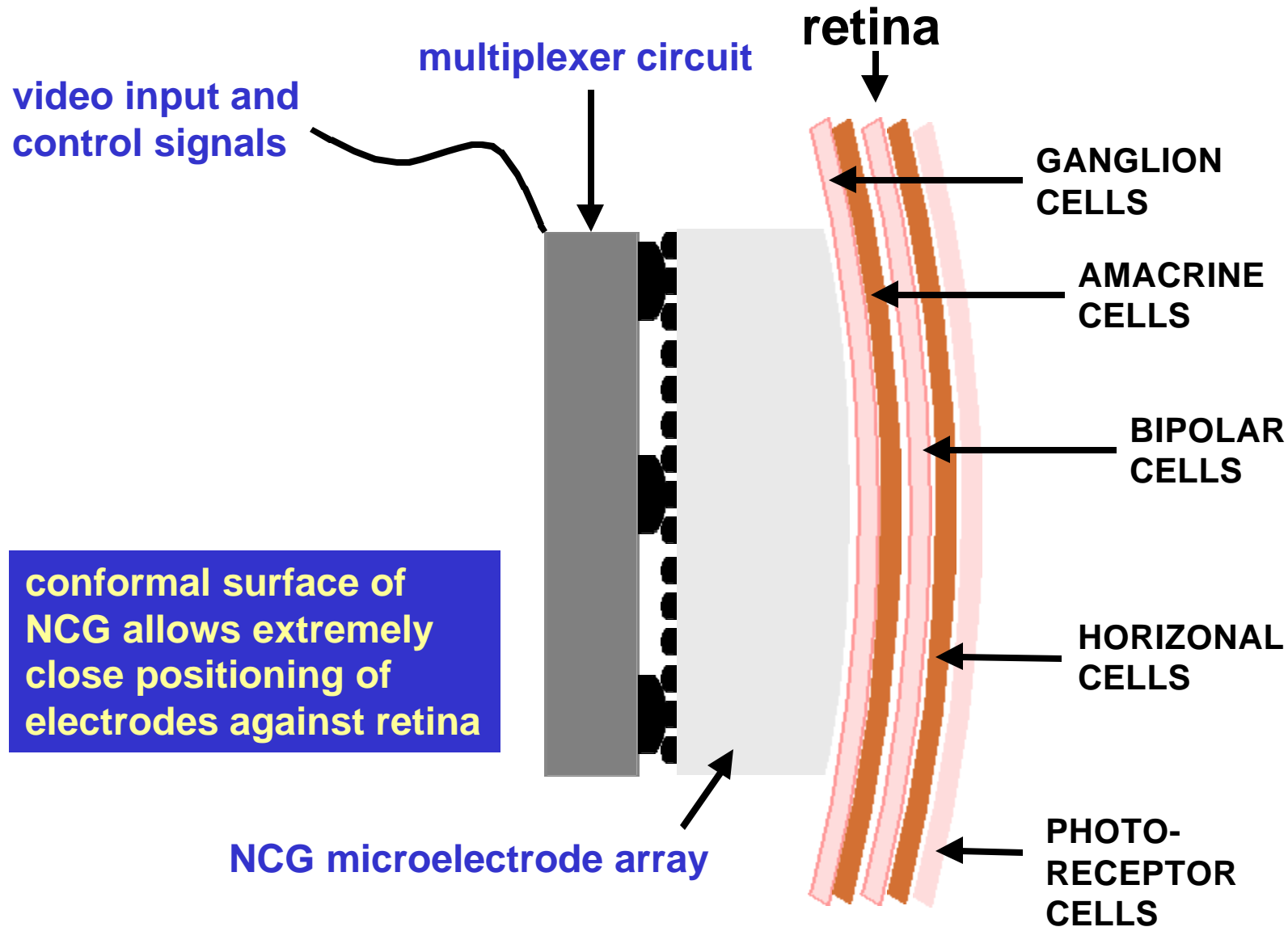



Chemical and Biological Sensing using Luminescent Quantum Dots

Objectives:

- Develop new, biologically active, luminescent materials by conjugating luminescent semiconductor quantum dots with biological species.
- Utilize luminescent quantum dot conjugates for sensitive detection of chemicals and biological materials.

Investigators:

Hedi Mattoussi and Keith Higginson
Optical Sciences Division, NRL

Matt Mauro, George Anderson,
Ellen Goldman and Phan Tran
Center for Biomolecular Science
and Engineering, NRL

Moungi Bawendi
Chemistry Department, MIT

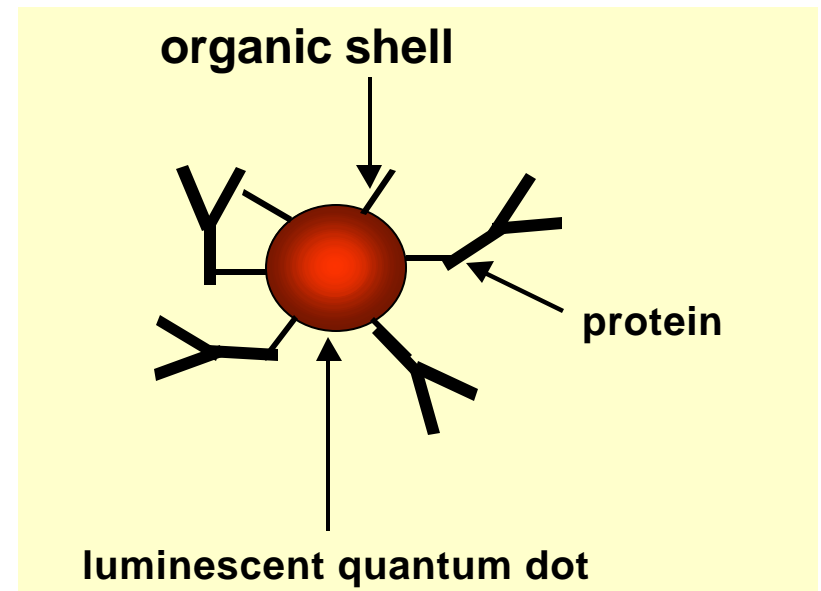

Research supported by the
Office of Naval Research



Chemical and Biological Detection using Luminescent Quantum Dots

Fluorescent-labelled ligands are widely used for the detection of biological molecules. Luminescent CdSe quantum dot labels have significant advantages over traditional organic dye labels.

Advantages of the approach:

- QD luminescence is spectrally narrow, permits sensing of multiple species using many colors
- a single UV laser can excite emission from QDs of every color
- QDs resist photobleaching

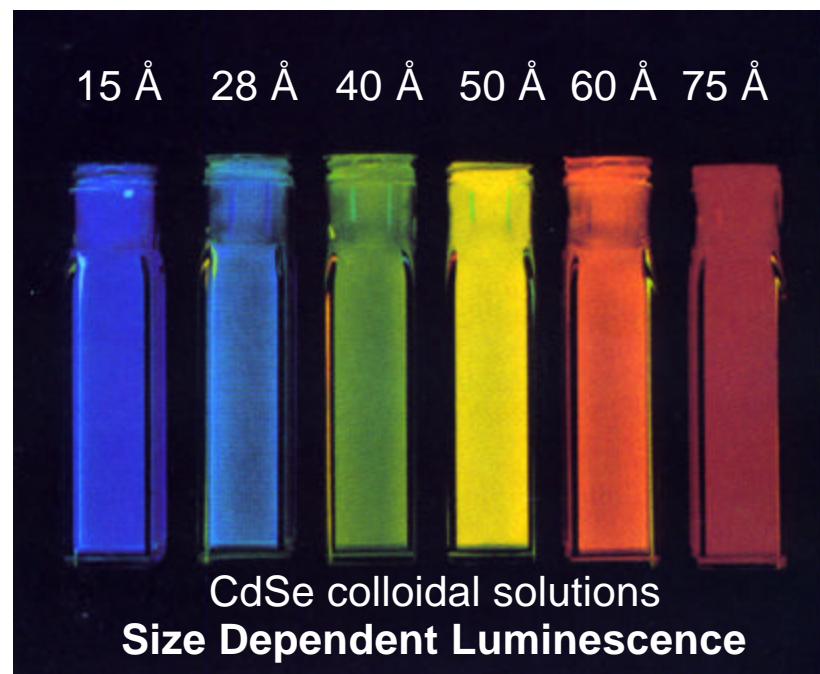
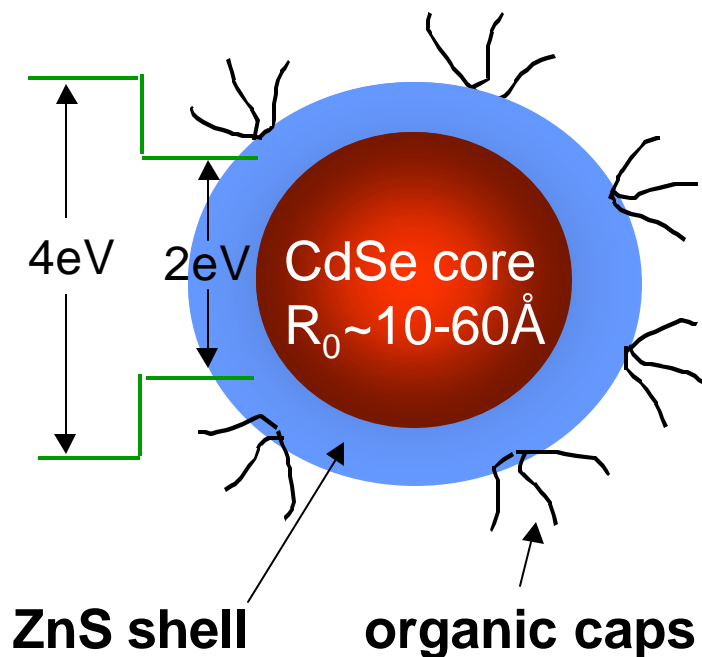

Electrostatically-driven QD bioconjugation

CdSe-ZnS QDs functionalized with dihydrolipoic acid

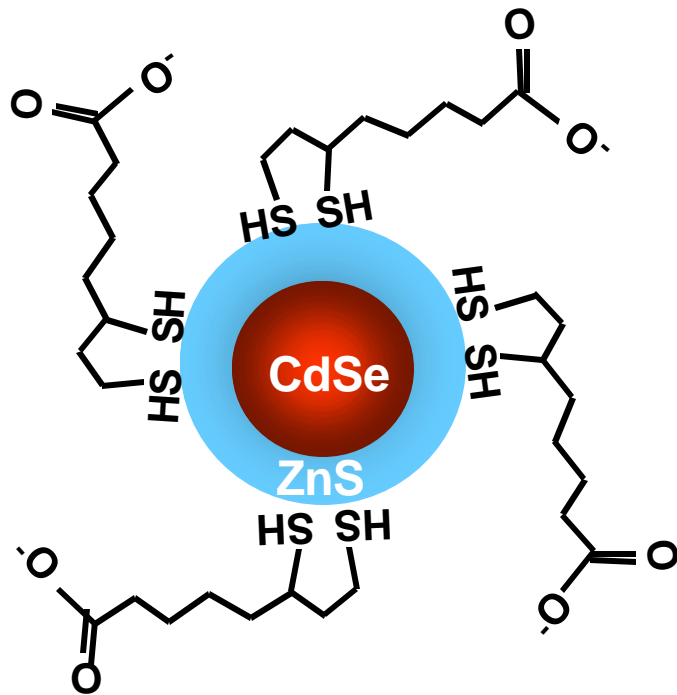

two-domain protein dimer with a charged peptide tail

maltose binding protein

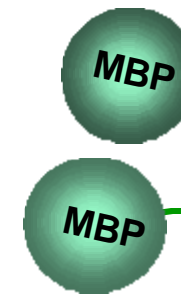

leucine zipper

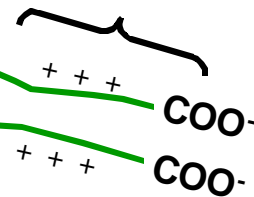

electrostatic



attraction

- pH of solution adjusted to ensure negatively charged ligands
- QD possesses high quantum yield

- positively charged tail is attracted to negatively charged ligands on QD
- maltose binding protein (MBP) possesses biological binding activity

Biologically Active, Luminescent QD/Bioconjugates

Electrostatic attraction results in self-assembly of a conjugate that is both biologically active and highly luminescent.

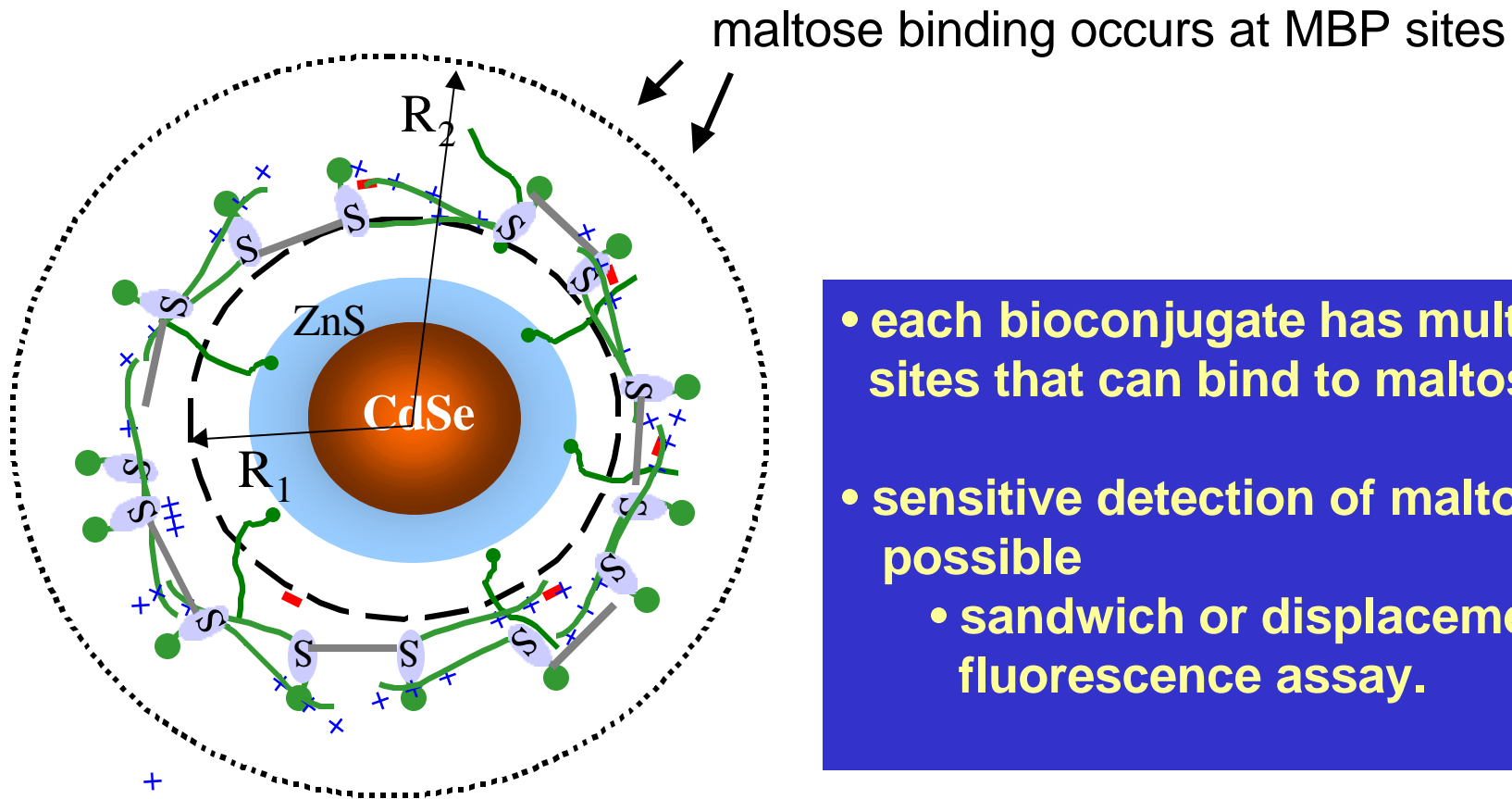

QD/MBP-LZ bioconjugate

- each bioconjugate has multiple sites that can bind to maltose.
- sensitive detection of maltose possible
 - sandwich or displacement fluorescence assay.

Fluorescence Assay Employing QD/MBP-LZ Conjugates: Detection of Maltose

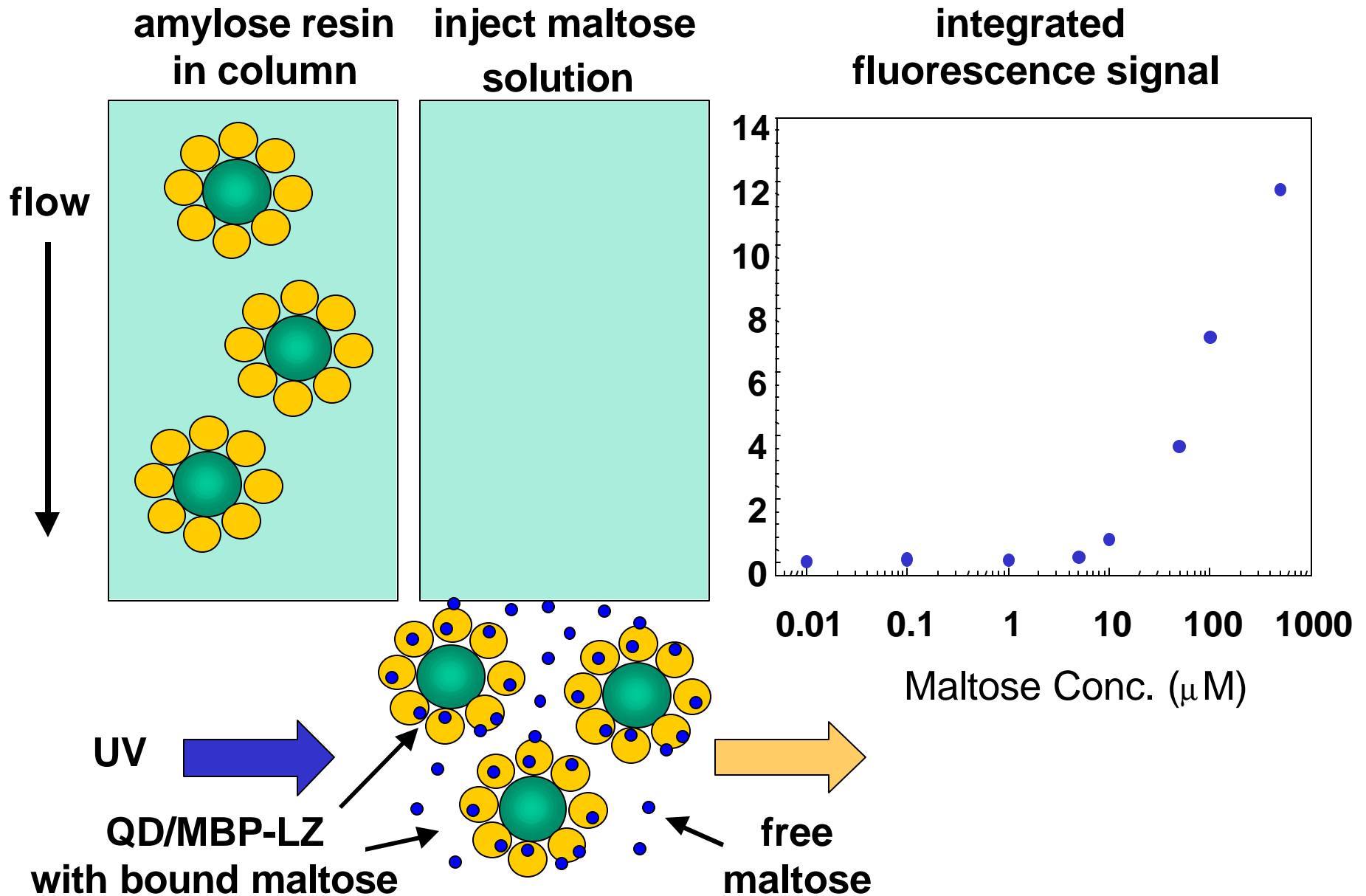



Optical Methods for Radiation Dosimetry

Objectives:

- Develop novel glass phosphors that exhibit optically stimulated luminescence (OSL) for the detection of ionizing radiation.
- Utilize the OSL glasses in medical, industrial and environmental sensing applications.
 - in vivo, real-time patient dose verification during radiotherapy
 - treatment planning
 - portal imaging dosimetry
 - remote ground water monitoring

Research supported by the
Army Medical Research and
Materiel Command

Investigators:

Alan Huston, Paul Falkenstein
and Brian Justus
Optical Sciences Division, NRL

Rosemary Altemus, Bob
Miller and Holly Ning
Radiation Oncology Branch
National Cancer Institute

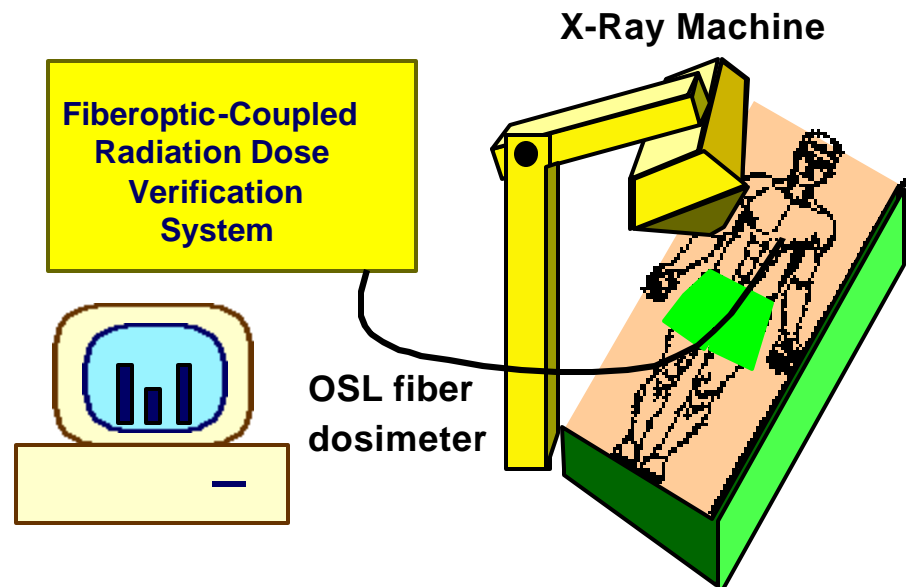



Charge-Trapping Glasses

Semiconductor and metal ion-doped glass

- ZnS:Eu doped Vycor
- Cu doped fused quartz

- Radiation produces carriers
- Charges trapped at defects
- Populated traps metastable
- Trap depopulation
 - thermal stimulation
 - optical stimulation
- Carriers retrap or recombine
 - thermoluminescence
 - OSL

Luminescence is directly proportional to absorbed radiation dose.

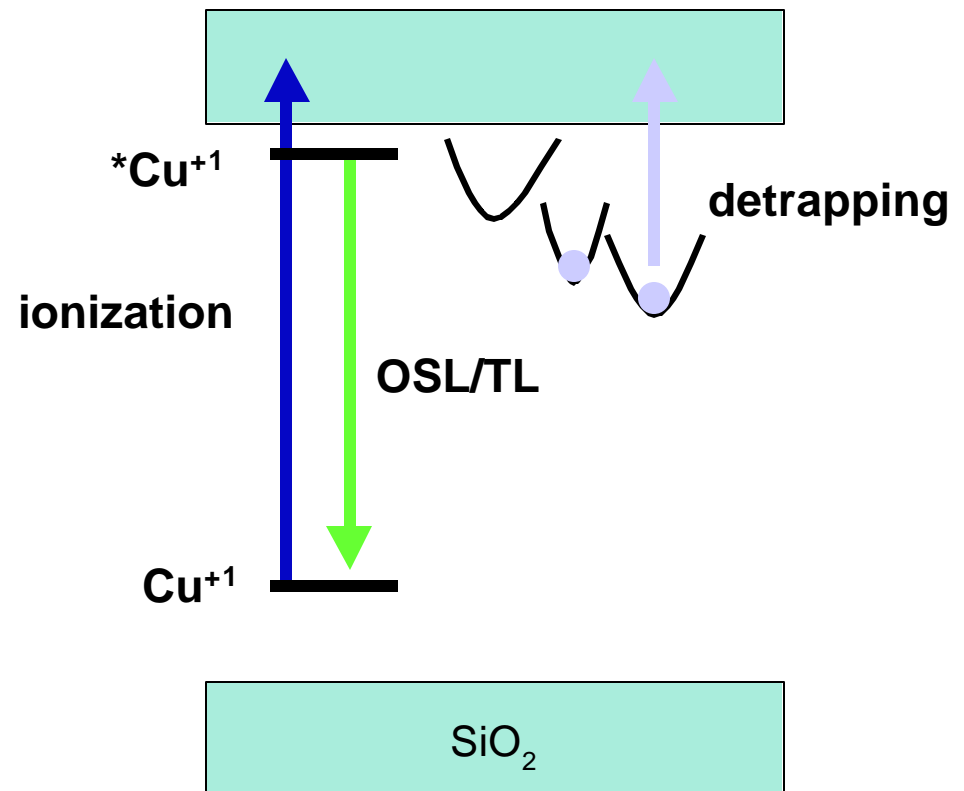



FiberOptic-Coupled Dosimetry

Remote radiation sensing using fiberoptic-coupled OSL dosimeter

- OSL quartz fiber fused to multimode optical fiber
- **Medical applications**
 - Measure entire range of relevant doses
- **Environmental applications**
 - Measure background dose

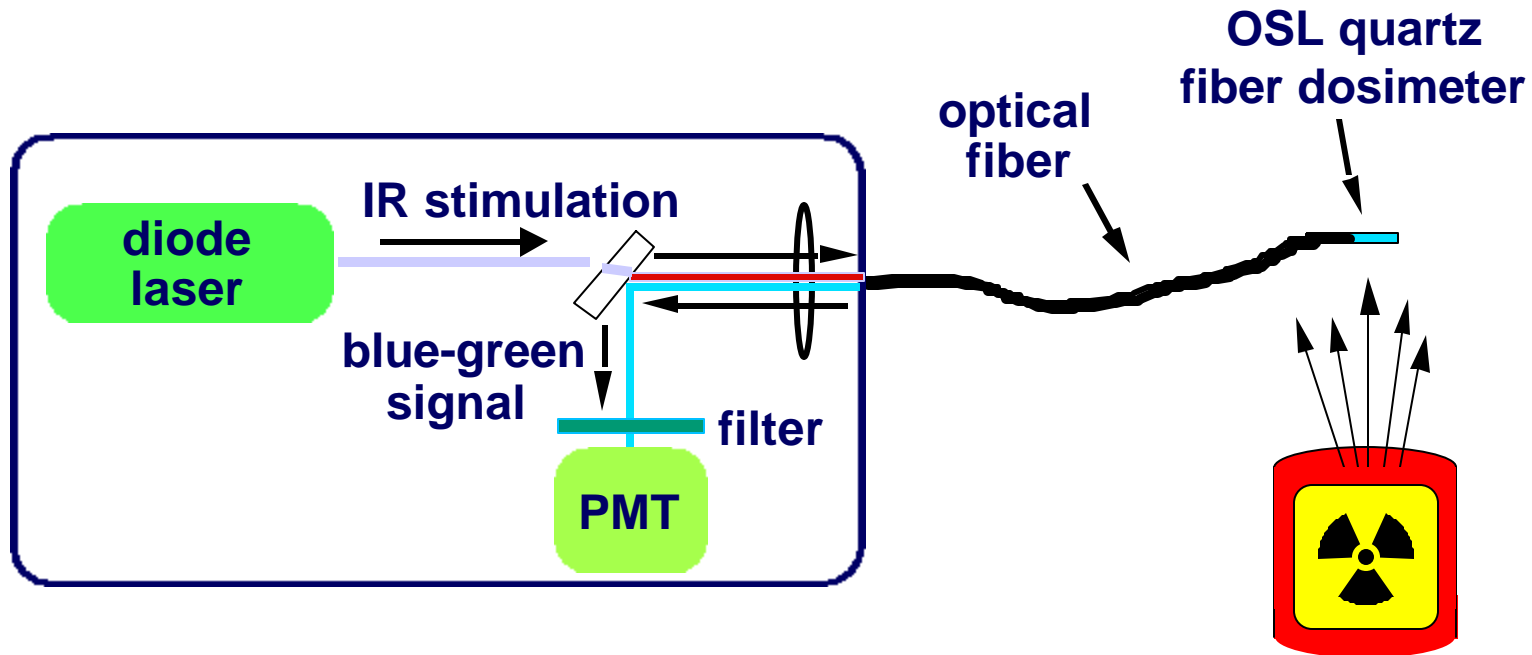



Optically Stimulated Luminescence 2-D Imaging

Objective:

Flexible, radiation sensitive sheets containing a thin film of optically stimulated luminescence (OSL) glass powder are used to collect digitized images of both hard and tissue equivalent materials.

Advantages of the approach:

- compared to x-ray film
 - linear response
 - wide dynamic range
 - reusable
 - no hazardous chemical disposal
 - provides quantitative measure of radiation dose
- compared to amorphous Si plates
 - large area
 - lower cost
 - x-ray sensitivity

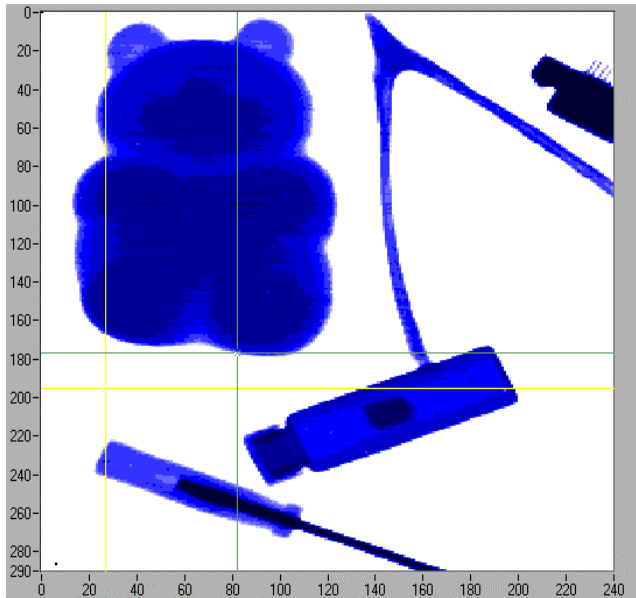

x-ray image of turkey wishbone,
screwdriver, glass vial, electrical
connector and large gummy bear



Bio-Warfare Detection

Bio-warfare/terrorism represents significant worldwide DoD and civilian threat.* Attack might not be obvious until hours/days later. Reliable real-time detection and early warning systems needed.

**“...there are no reliable BW detection devices currently available”
*Jane’s US Chemical-Biological Defense Handbook, 1998.***

*Threat level is typically 10 g per sq. mile (" 1 particle/liter)

OSD Approach: Optical Point Detection
*J. Eversole, W. Cary, M. Seaver, J. Koplow,
R. Pierson, R. Ramamurti and A. Campillo*



Bio-Aerosol Cluster
Collected at NRL



Technical Approach - Single Particle Detection

Using two laser excitation: cw 780 nm beam for elastic scattering sizing, and on-demand 10 nsec 266 nm pulses for fluorescence monitoring.

Program Structure encouraged modular design for flexibility and expandability

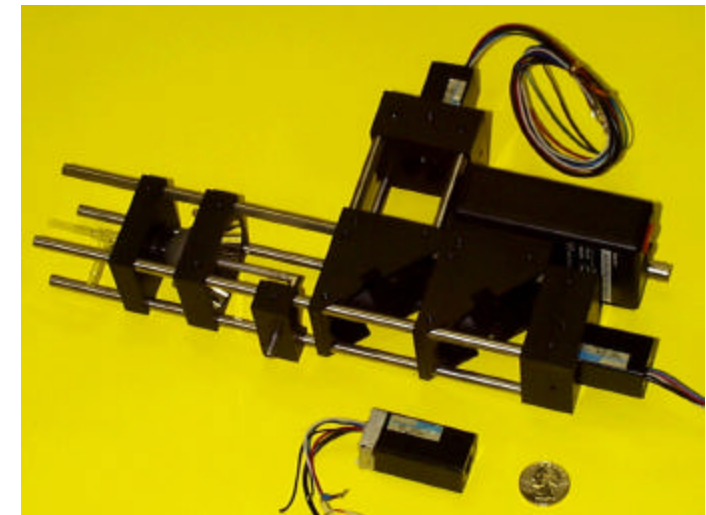
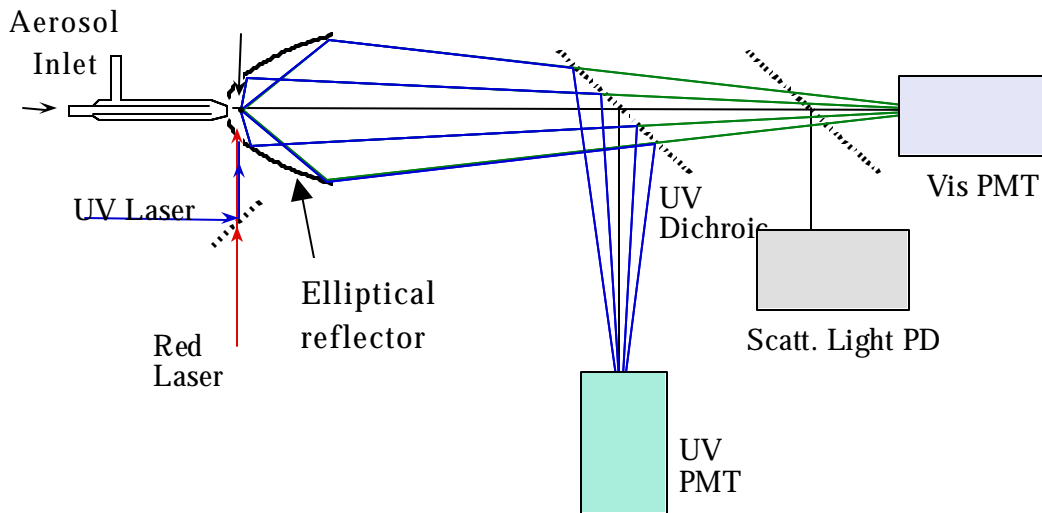

Data:

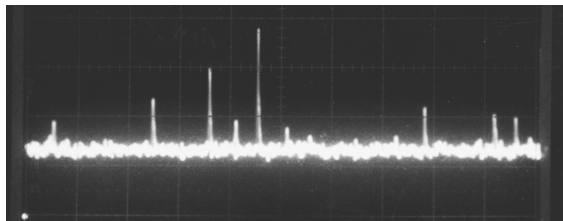

| time | scatter | fluorescence | |
|------|---------|--------------|------|
| | | UV | VIS |
| | | | |

A complete digital record is stored for each particle



Early Morning BioAerosols

Not only does the total count rate decrease after sunrise, but the fluorescence intensity drops significantly as well.

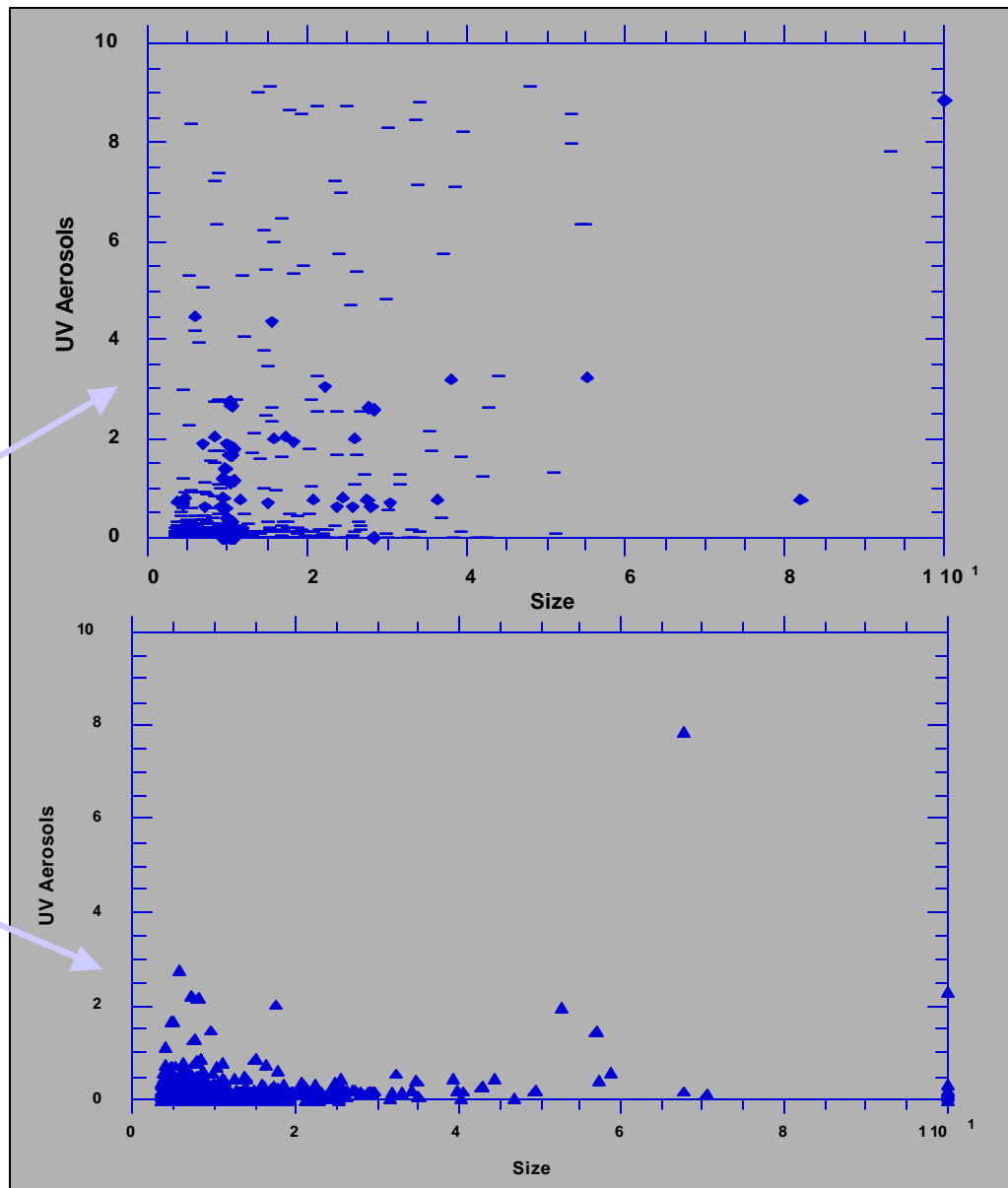
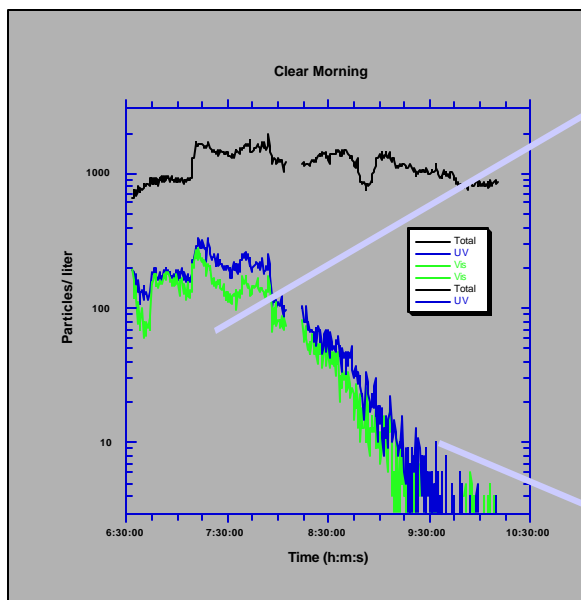



Custom Laser Development

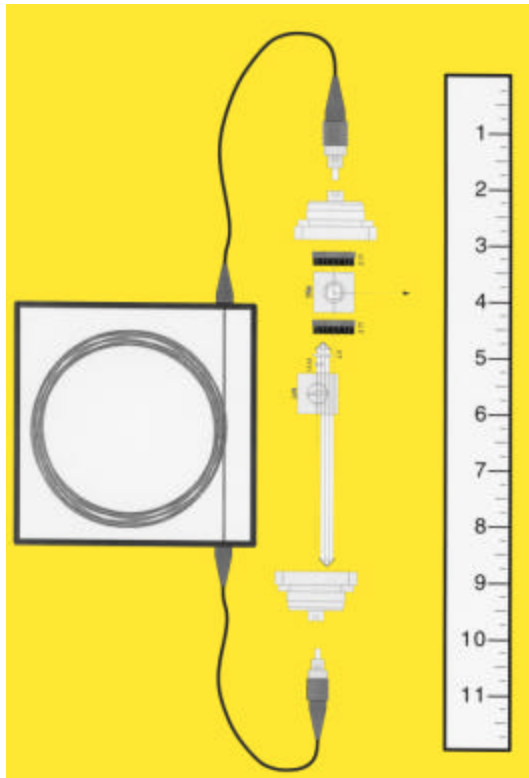

Q-switched Yb Fiber Laser

Projected UV Laser Specs.:
(equal or better than Nd:YAG)

- Drastic reduction in size and weight
- Peak power: >10 kW
- 200 ns trigger latency
- PRF: > 50 kHz
- tunes over 270 - 280 nm
- 8% wall plug efficiency
(compared to 3% Nd:YAG)



**Current Instrument with COTS Nd:YAG laser
(4"x4"x16" and 6"x19"x18")**



Program Approach - New Signature Research

Angular (3-D) Light Scattering

- Previous evaluation of candidate optical signals shows angular scattering (flow cytometry) as “best bet”
- Shape and index discrimination using angular scattered light lab-based evaluation started
- Initial experiments are to evaluate utility of the data for discrimination
- Inlet nozzle design CFD analysis will provide orientation forces evaluation
- Application of the technique will require algorithm development, UV fluorescence is the first filter

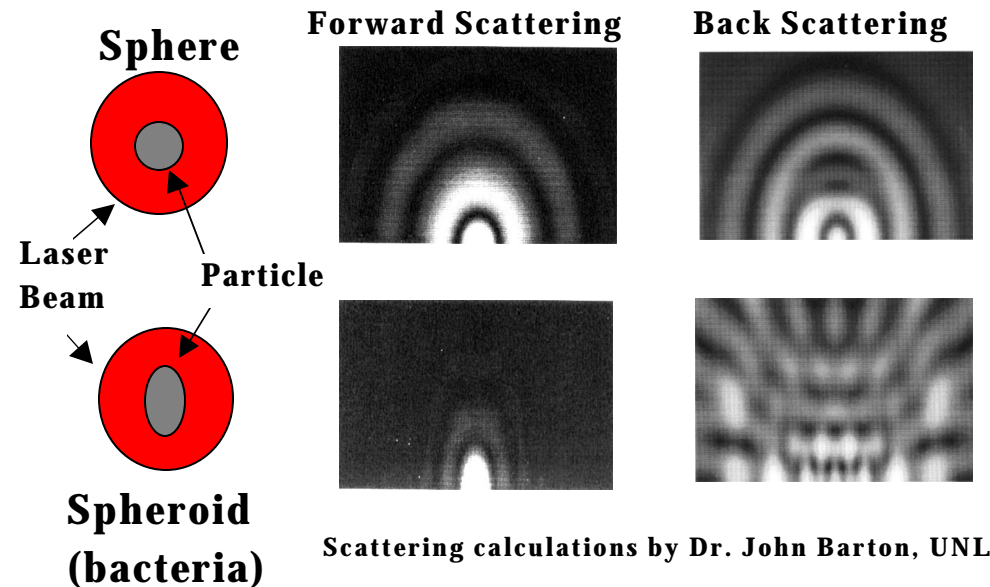
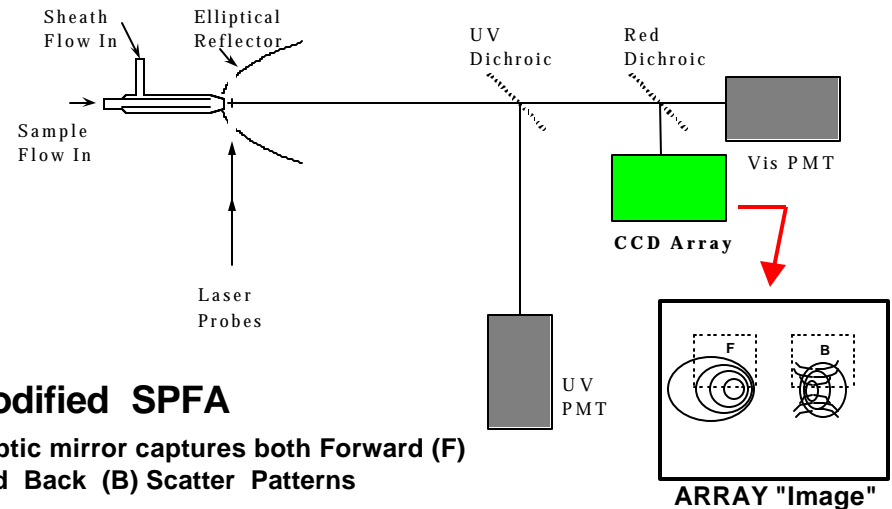



CFD Simulation of Nozzle Flow

Computational model will optimize particle trajectory and focus

Nozzle Geometry and Flow Conditions

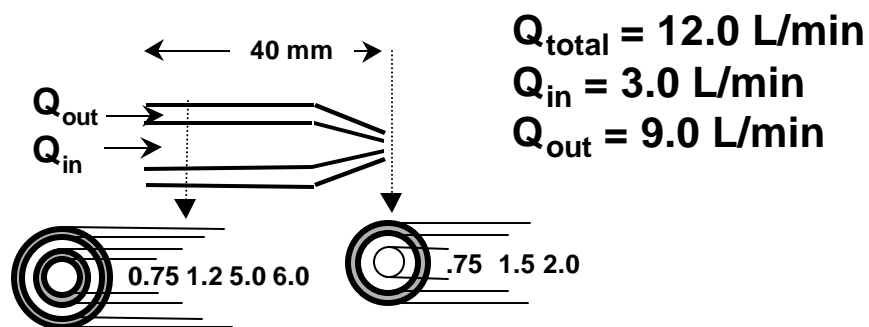

Computed $\Delta p = 47.5 \text{ torr}$, Exptl. $\Delta p \sim 45.0 \text{ torr}$

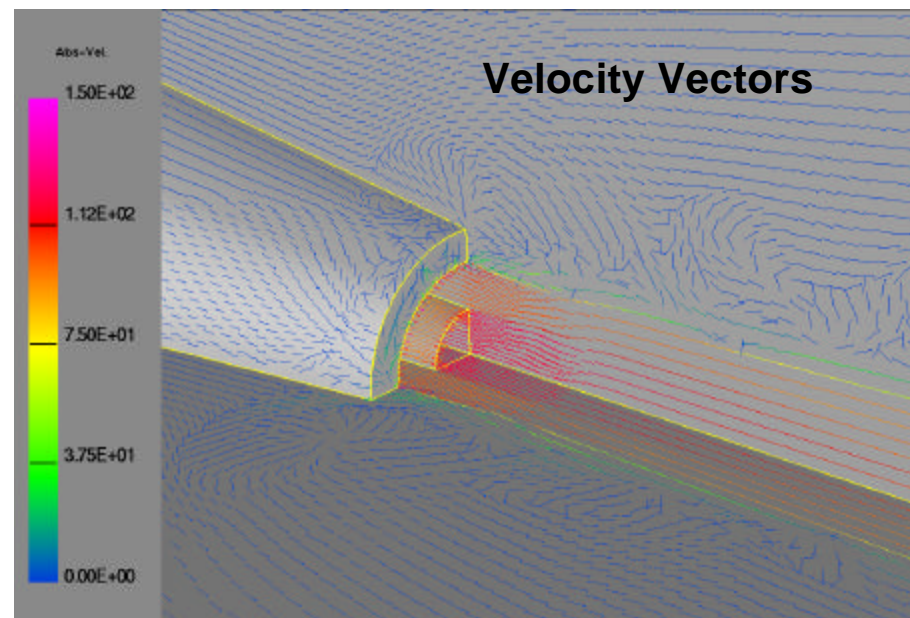
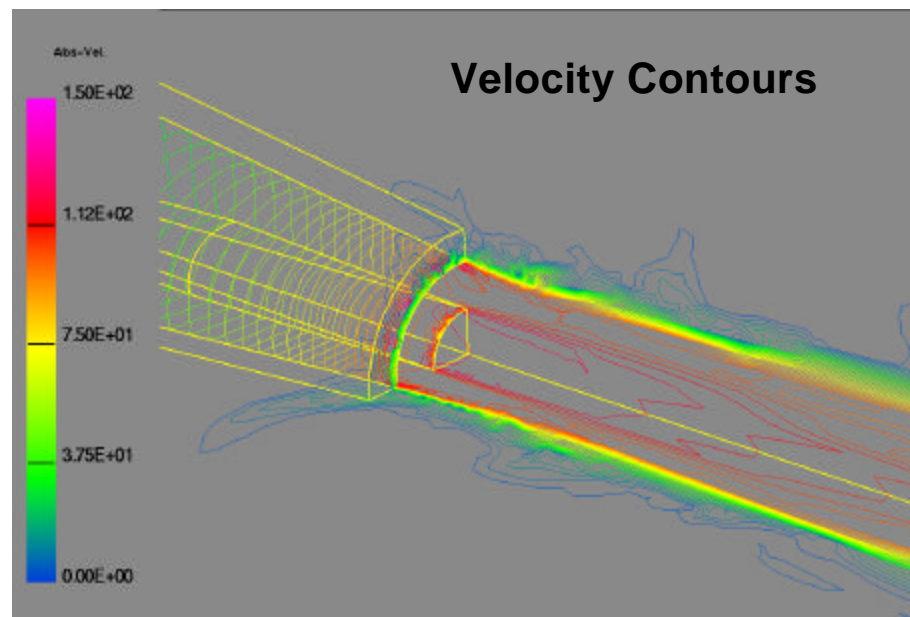
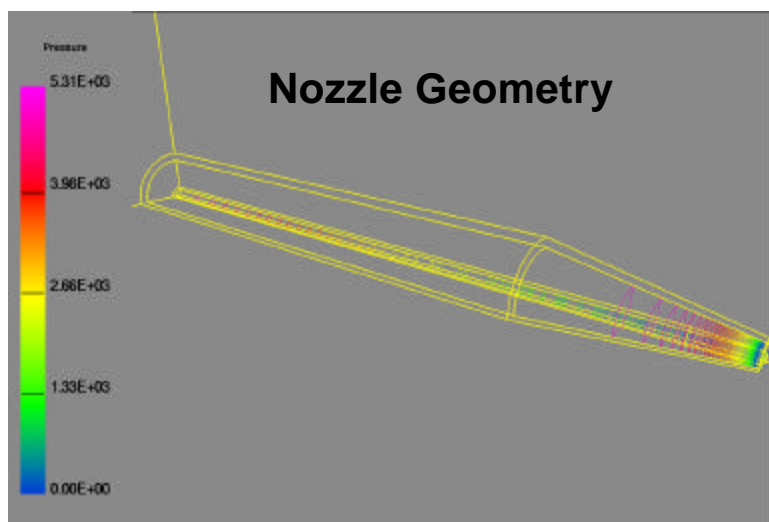



SUMMARY



Several examples presented of Science & Technology leading to new DoD capabilities :

Countermeasures to heat-seeking missiles

Eye protection from laser threats

Flexible organic emissive displays

Nanopatterned materials

Neural interfaces

Biological / chemical sensing

Radiation dosimetry

Collaborations welcomed on these projects !